

BENN'S ENCYCLOPAEDIA OF HARDWARE

1954

THE HARDWARE
BOUVERIE HOUSE

TRADE JOURNAL
LONDON E.C.4.

100% British



NETTLEFOLDS SCREWS

The Standard Quality all over the World

GKN GUEST KEEN & NETTLEFOLDS
(MIDLANDS) LTD BIRMINGHAM 18



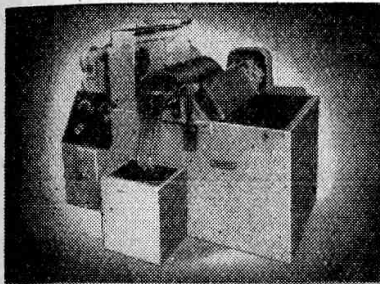

AUTOMATIC PLATING BARRELS

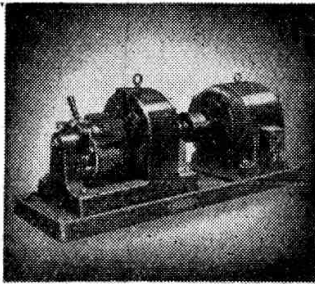

MOTOR GENERATORS

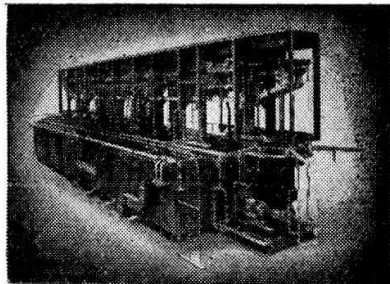

AUTOMATIC PLATING EQUIPMENT

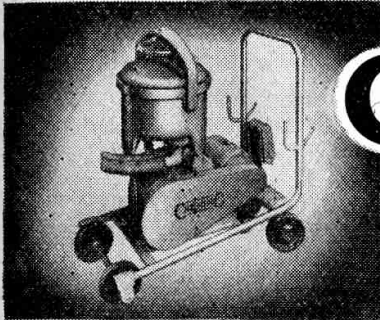

PORTABLE FILTER UNITS



**EQUIPMENT
AND
MATERIALS**
for
**ELECTRO-
DEPOSITION
& POLISHING OF
NICKEL
CHROME
CADMIUM
COPPER
GOLD, SILVER
BRASS, ZINC
AND TIN**

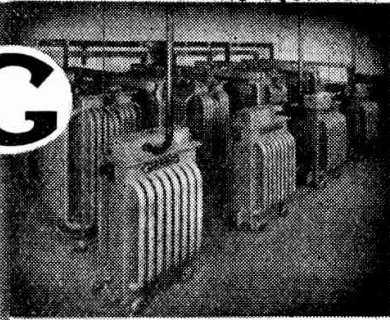

RECTIFIERS

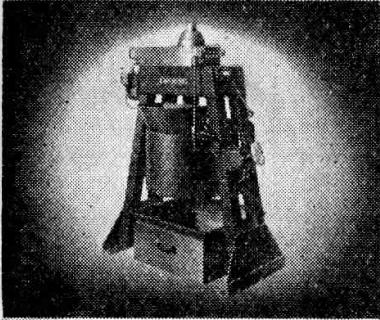

CENTRIFUGAL DRYERS

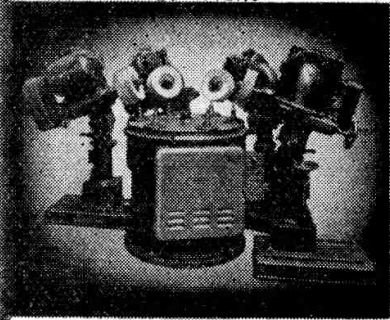

AUTOMATIC POLISHING MACHINES

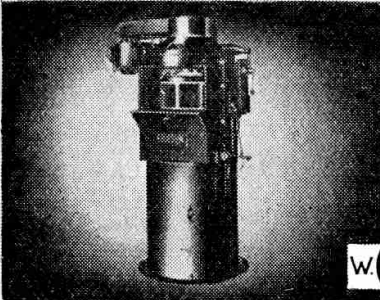

CENTRIFUGAL LACQUERING MACHINES

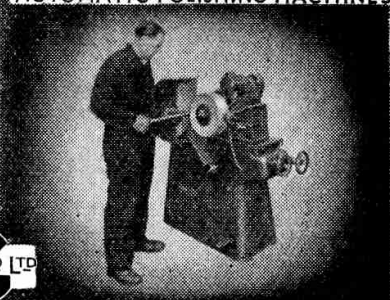

CENTRELESS POLISHING MACHINES



**BIRMINGHAM 18
LONDON & SHEFFIELD**

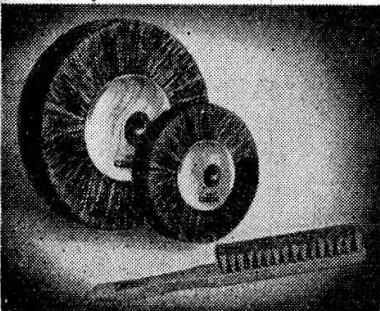

WHEELS AND BRUSHES



POLISHING COMPOSITIONS

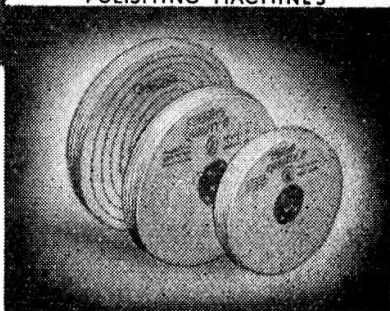

POLISHING MOPS



More than 100 years experience goes into the manufacture of CHATWIN tools. They are recognised the World over as the best obtainable: the name alone is a guarantee of accuracy.

CHATWIN SMALL TOOLS

Chaser Die Stocks · Clyburn Spanners · Stillson Pattern Wrenches · Pipe Cutters
 Pipe Unions · Thread Milling Cutters · Flat and Circular Chasers · Gear Cutters
 Form Tools and other Screwing Tools, Screwing Machines and
 The Polygon Box

THOMAS CHATWIN & CO.

VICTORIA WORKS, GT. TINDAL STREET
 BIRMINGHAM 16. Tel: Edgbaston 3521

London Office:
 1. Great Winchester St., E.C.2
 Telephone:
 London Wall 4912



★ NAME STAMPS AND PUNCHES

★ DIES ★ RUBBER STAMPS

★ BRANDING IRONS

★ STENCILS IN PLATES, SETS A-Z & 0-8. STENCIL INK

★ STAMPED METAL LABELS

★ STEEL STAMPS

★ SETS OF LETTERS AND FIGURES

★ ENGRAVED NAME PLATES



GEO · E · DEAN

29 EYRE STREET · SHEFFIELD 1

PHONE: 24755

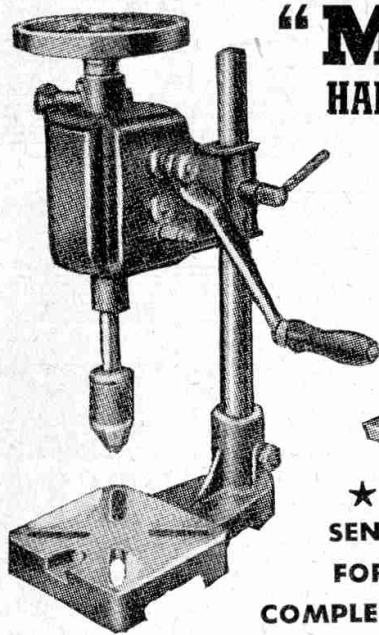

“METABO” WORLD FAMOUS!
HAND DRILLS, BENCH DRILLS, HAND GRINDERS,
JUST A SELECTION

SUPERB
 FINISH
 AND
 WORK-
 MANSHIP

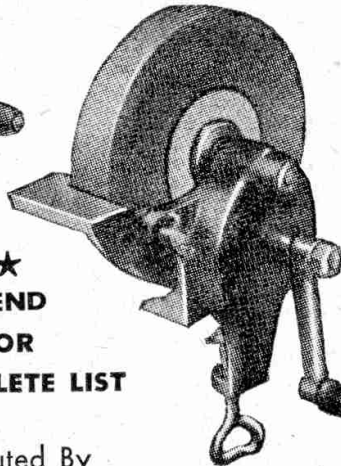

★
 SEND
 FOR
 COMPLETE LIST

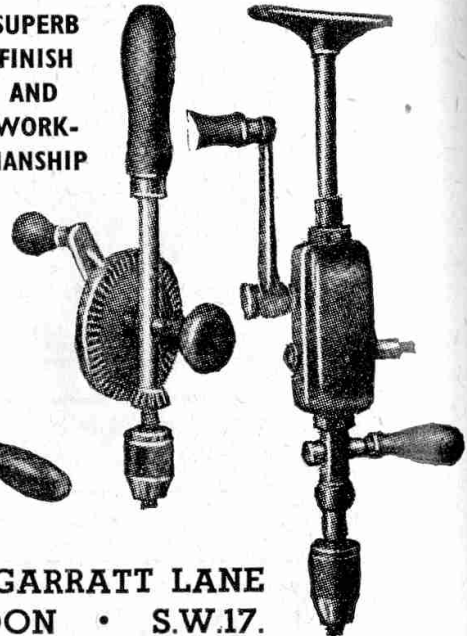

Imported & Distributed By

WM. URQUHART

1023 GARRATT LANE
 LONDON • S.W.17.

Phone: BALham 3351 * Grams: "Urquhartvi, Souphone, London."

CASES & BOXES

for

INSTRUMENTS, GAUGES

AND TOOLS OF ANY KIND

DESIGNED FITTED AND PRODUCED

BY

E. GREAVES & SON (CASE MAKERS) LTD.

IN POLISHED WOOD, REXINE COVERED, LINED OR UNLINED

Send us your blueprints, or prototypes

Phone : 25181

Exchange Works, Sidney Street, Sheffield 1

ACHIEVEMENTS OF BRITISH ENGINEERING

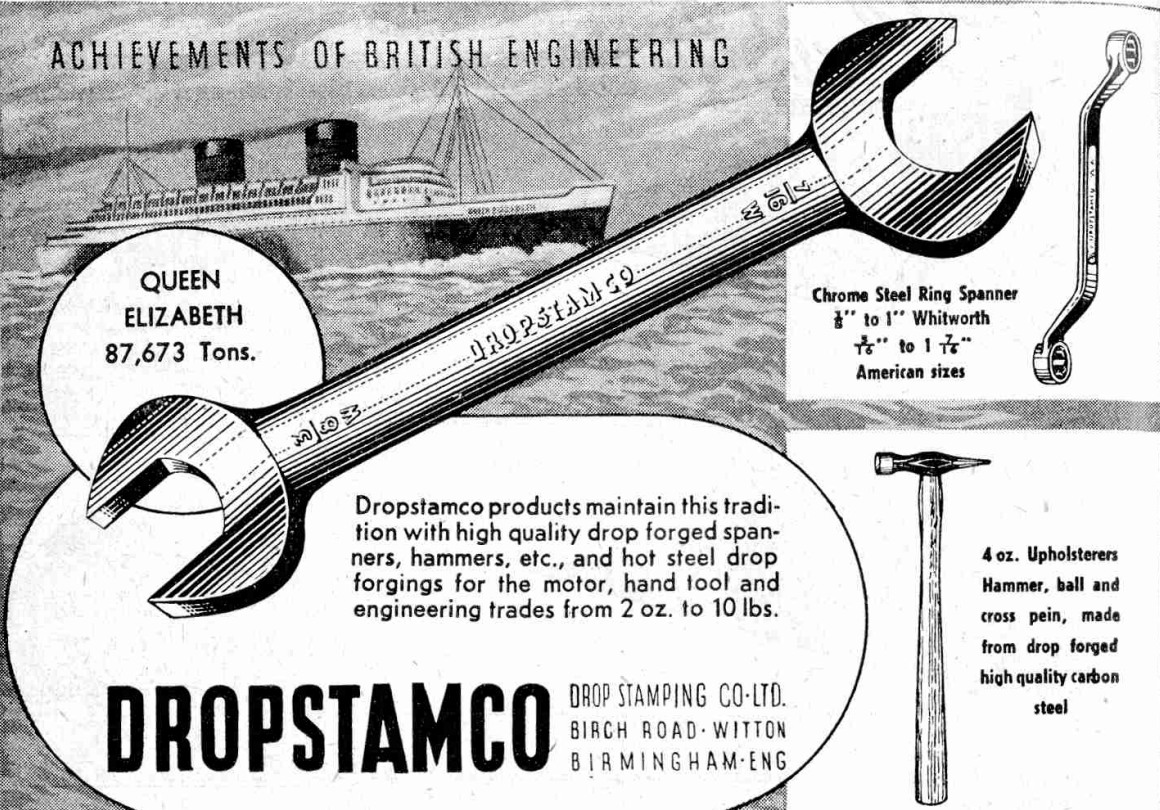

**QUEEN
ELIZABETH**
87,673 Tons.

Chrome Steel Ring Spanner
 $\frac{3}{8}$ " to 1" Whitworth
 $\frac{7}{8}$ " to 1 $\frac{1}{2}$ "
 American sizes

Dropstamco products maintain this tradi-
 tion with high quality drop forged span-
 ners, hammers, etc., and hot steel drop
 forgings for the motor, hand tool and
 engineering trades from 2 oz. to 10 lbs.

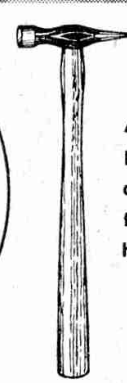

4 oz. Upholsterers
 Hammer, ball and
 cross pein, made
 from drop forged
 high quality carbon
 steel

DROPSTAMCO

DROP STAMPING CO. LTD.
 BIRCH ROAD · WITTON
 BIRMINGHAM · ENG



Illustrating No. 5 Size—14" Wheel

SWING FRAME GRINDERS

We offer the largest range of this
 type of machine to be had in the
 country. Machines with 6" diam.
 wheels up to 20" diam. Heavy
 duty billet grinders.

*Enquiries for this type machine are
 most welcome*

WILKINSON, BENTLEY
 & CO. LTD.

EBENEZER WORKS · MORPETH STREET
SHEFFIELD · 3 Phone : 22797



ERMA
 PRECISION
WIRE STRIPPER

*It's Quick
 Neat
 Light
 Modern*

THIS WIRE STRIPPER IS A PRECISION TOOL
 WHICH DOES NOT DAMAGE THE CONDUCTOR.
 IT CAN ALSO BE USED FOR CUTTING WIRE.
 ALL PARTS ARE INTERCHANGEABLE

MANUFACTURED BY

ERMA LIMITED

HONG KONG WORKS · EXHIBITION GROUNDS
 WEMBLEY, MIDDLESEX

. . . wrestling with tube bending problems

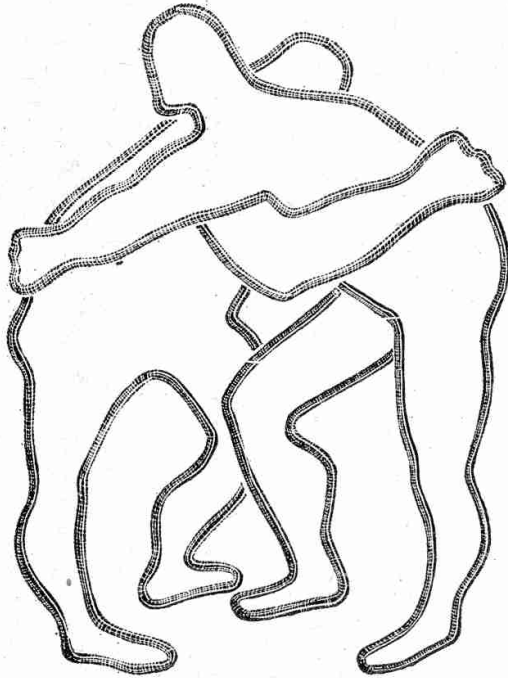

Our bent is tube bending equipment. We design and manufacture a range of machines famous for bending steam and gas tubing—copper tubing—electricians conduits—light gauge solid drawn brass tubing—aluminium tubing and light gauge steel tubing into all or any of the innumerable shapes which fancy may suggest or necessity dictate.

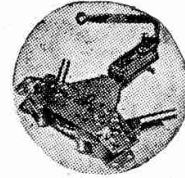

Tubela

*Tubela Engineering Co. Ltd.
6 Furze Street, London, E.3
Telephone: East 4771 (3 lines)*

Elwyn Hughes

HAZLEWOOD & DENT LTD
MACHINE TOOL MAKERS
GENERAL ENGINEERS & MILL FURNISHERS

SPINNING LATHES AND PRESSES

ARBOR PRESSES
HAND PRESSES
BOLSTERS
SPINNING LATHES UP TO 84" BLANK
TRIMMING AND BEADING LATHES
GANG PIERCING PRESSES
MACHINE HAZDENT TOOLS

GREAT HAMPTON ST. & BARR ST. BIRMINGHAM, 18

Phone: NORTHERN 2031-2
Grams: HAZDENT BIRMINGHAM

These New **MYFORD**
PRODUCTS
mean more
BUSINESS
FOR YOU

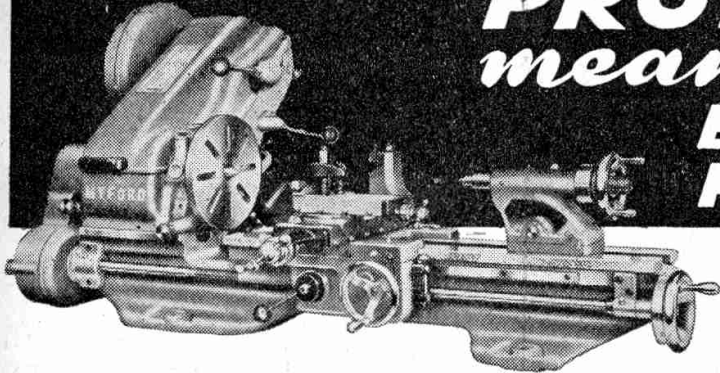

SUPER-7 HIGH-SPEED 3 1/2" LATHE
From 2150-25 rpm. Produced mainly for the industrial user and instrument maker where higher speeds are essential. Sixteen speeds. Takes all ML7 Lathe accessories.



ML8 BANDSAW ATTACHMENT

Makes possible another vital job on the ML8 Lathe — straight or curved sawing up to 3 3/4" thick.

£23·15·0

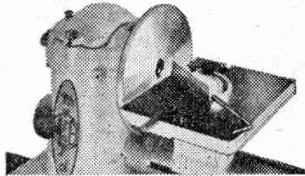

ML8 DISC SANDER

For Right-Hand mounting on the ML8 Lathe. Diameter 8". Larger 10" size for L.H. mounting available.

£3·15·0

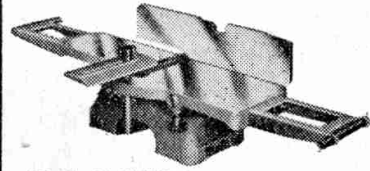

PR11 PLANER

This 4 1/2" Planer takes the hard work out of hand planing and jointing. For small workshops, schools, etc.

£17·10·0

↓ **FOR THE ML7 3 1/2" LATHE** ↓

Many thousands of ML7's are in use all over the world and these new items will have a ready sale. Put one of each in your window to stimulate local demand.



LATHE COVER

Durable plastic cloth and tailored to fit. Protects the lathe from damp, dust, prevents rust.

£1·6·3

FINE FEED CLUSTER GEAR



Permits a feed of .002" per spindle rev. 11/6 each

TUFNOL SILENT TUMBLER PINIONS

Give silent running at high speeds. 12/6 per pair

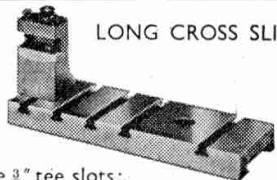

LONG CROSS SLIDE

Five 3/8" tee slots; permits mounting of Rear Tool Post. Slide £2·17·9 Tool Post £1·15·6

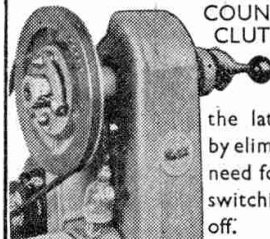

COUNTERSHAFT CLUTCH UNIT

Protects the lathe motor by eliminating the need for constant switching on and off. £5·15·0

MULTI-STOP

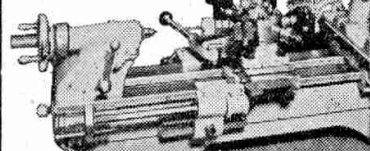

Used with I408 Turret Attachment for repetition work. £4·0·9

ALL GOOD TOOL MERCHANTS SELL

MYFORD LATHES & ACCESSORIES

Prices apply in Great Britain and Northern Ireland only.

MYFORD ENGINEERING COMPANY LTD

BEESTON · NOTTINGHAM · 'Phone: 54222 (3 lines)

Send Now

for New Brochure detailing all points and interesting features ; answered questions you would ask, showing machines in use and articles such as toys, patterns and turnery made on these machines. Ask also for details of fitments to the "Coronet" range and other makes. Is long hole drilling a problem to you ? Send now for details of BORING ATTACHMENT and long drills, to suit any lathes.

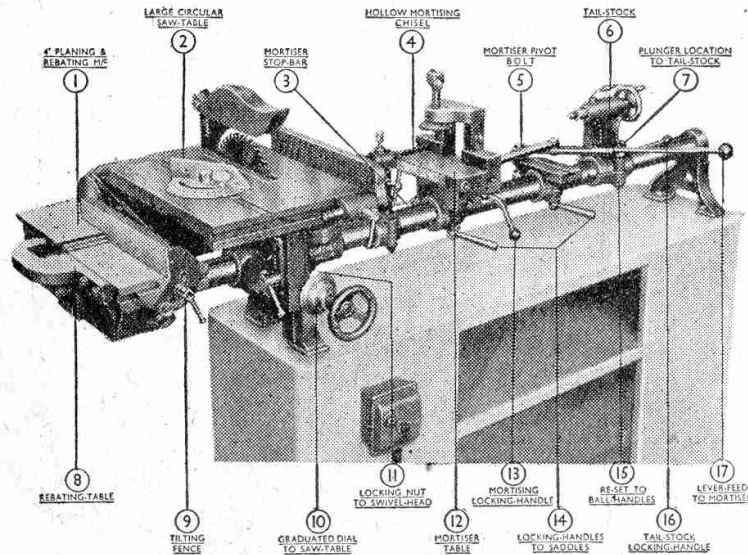

12 MAJOR MACHINES IN ONE. Performs all the following operations in batteries of three machines.

- Planing.
- Circular Sawing.
- Mortising.
- Spindle Moulding.
- Belt Sanding.
- Bandsawing
- Disc Sanding.
- Repetition Woodturning.
- Flexible Drive Tool.
- Grinder, etc.

CORONET TOOL CO., 8 Mansfield Road, DERBY

Also at **CITY ROAD MILLS, DERBY**



**J. P. UDAL, INTERLOCK WORKS,
COURT ROAD, BIRMINGHAM 12**

Phone: CALthorpe 3114

and £4,000 damages

A press operator whose earnings are retarded by slow guard operation is a menace to himself and to you. He is tempted to expose himself to danger and may involve you in heavy damages. Fortunately, the 'Fastrip' Synchronised Guard ensures the highest standard of safety without impeding production. Send for full details today.



PLANT AND PRESS TOOL SPECIALISTS

TO THE
SHEET METAL
WORKING
INDUSTRY



Our All-In Service includes:—

- ★ Supply of PRESSES & PRESS BRAKES, PLANT by the best British Makers.
- ★ TOOLS manufactured in our own Precision Tool Shops.
- ★ PRODUCTION LAYOUTS for manufacture of all Sheet Metal goods including most Hardware.
- ★ General CONSULTANT and ADVISORY Service.

SHEET METAL ENGINEERING CO., LTD.

BRIDGE STREET, MORLEY,
Nr. LEEDS.

Telephone: Morley 1085-6-7

Also at Shipley, Yorks.



"WELLIN" TOOLS

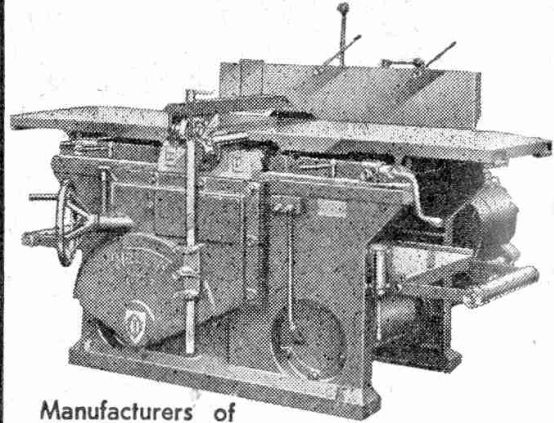

Manufacturers of
COMBINED SURFACERS & THICKNESSERS
SURFACE PLANERS, MORTICERS AND
SAWBENCHES

TURNELL & ODELL LTD.

WOODWORKING MACHINERY MANUFACTURERS
Wellingborough 2061

NORTHANTS

SAFETY EQUIPMENT



**SAFETY BELTS
and HARNESS**
with Special Ropes
and Fittings

RESPIRATORS and GAS MASKS
Welders' Shields

PROTECTIVE GLOVES & APRONS
in Leather, Rubber, Canvas and Asbestos

FIRST AID OUTFITS for WORKSHOPS
and VEHICLES

Goggles,
Face
Protectors



STENHOUSE EQUIPMENT CO.

SECURITY HOUSE, SYKES STREET
HULL

'Phone: 33045

BRASSFINISHERS' MACHINERY

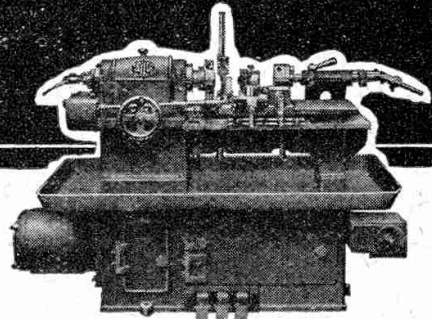

PLUGGING LATHES

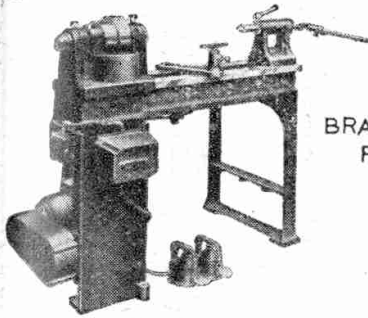

BRASSFINISHERS' REVERSING LATHES

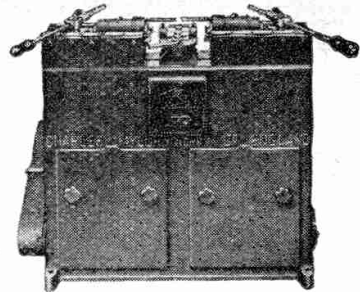

HINGE DRILLING MACHINES

by **TAYLOR**

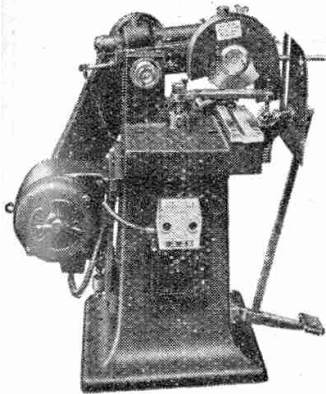

SAWING MACHINES

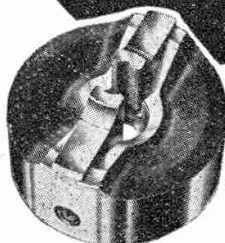

CHUCKS

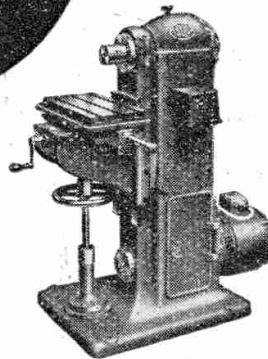

SINGLE BRASS MILLING MACHINES

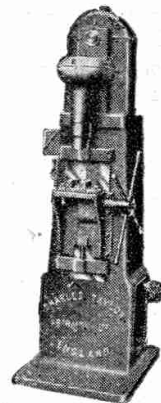

COCK BORING MACHINES

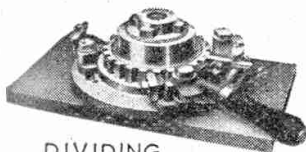

DIVIDING FIXTURES

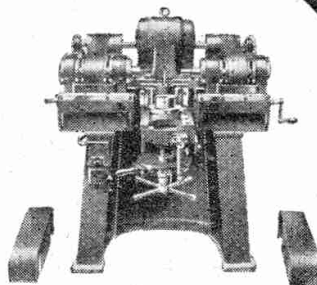

DOUBLE HEADED MILLING MACHINES

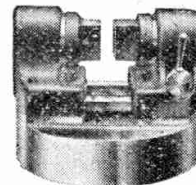

VALVE CHUCKS

TAYLOR
SEND FOR ANY OF THESE SECTIONAL CATALOGUES

SECTION 5---CAPSTAN LATHES AND TOOLHOLDERS
SECTION 6---CHUCKS, SELF-CENTRING
SECTION 7---CHUCKS, INDEPENDENT
SECTION 8---MACHINE VICES
SECTION 9---'KENNEDY' BENDING MACHINES
SECTION 11---CUTTING OFF MACHINES
SECTION 14---BRASSFINISHERS LATHES AND MACHINERY
SECTION 15---SPINNING LATHES
SECTION 19---METAL SAWING MACHINES
SECTION 21---COLLETS AND FEED FINGERS
LEAFLET A.D.398---DELLMAC PRECISION THREAD CHASING LATHE
LEAFLET A.D.313---JIGS AND FIXTURES

CHARLES TAYLOR (BIRM.) LTD.
BIRMINGHAM 5, ENGLAND

PRODUCTS

SEND FOR SECTION 14 CATALOGUE

CHARLES TAYLOR
(BIRM.) LTD.
BIRMINGHAM 5, ENGLAND.

TYZACK'S "ZYTO" MACHINERY for WOOD & METAL

★ **INCREASE YOUR SALES . . .**
with TYZACK'S "ZYTO" Machines—Well designed,
trouble free machines—Backed with our usual guarantee

TYZACK'S "ZYTO" Precision Saw Bench takes 10" saw. Parallel rise and fall Table, left and right canting. Will Rip, Crosscut, Groove, Bevel, Mitre, etc. Supplied as a Bench Model or Motorised on Stand complete. Vee Belt Drive. Extension Tables can be supplied giving greater table area. Send now for fully illustrated lists with prices and discounts.

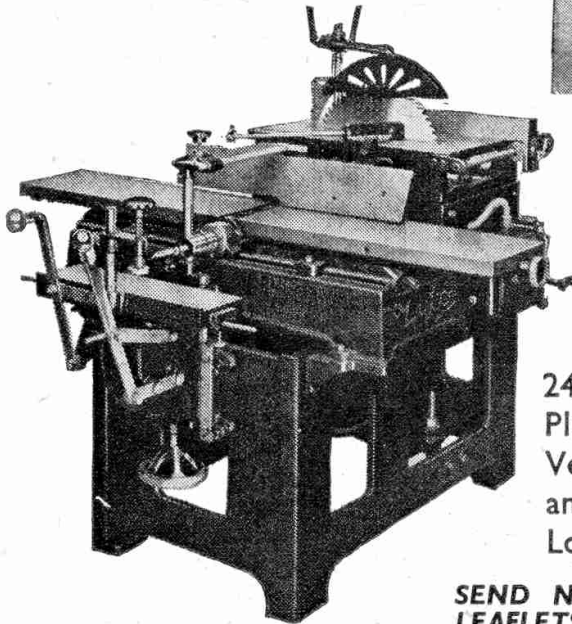
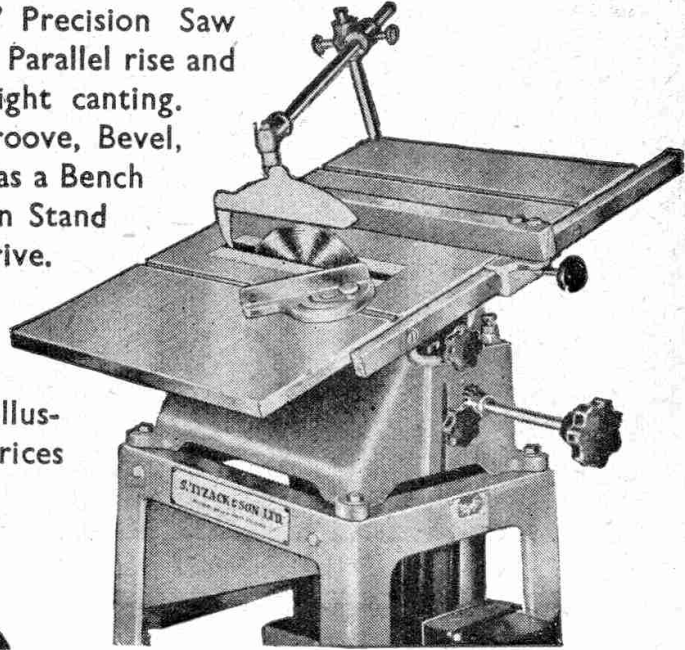

TYZACK'S "ZYTO" V.S.M. Combination Woodworker—Motorised complete in one unit. Will Rip, Crosscut, Plane, Groove, Rebate, Mitre, Bevel, Mortise.

24" × 18" Table takes 15" Saw. Planes up to 9" wide. Double Vee Belt Drive. Slot Mortiser and Boring attachment has Longitudinal Transverse.

**SEND NOW FOR FULLY ILLUSTRATED
LEAFLETS, PRICE AND DISCOUNTS**

The "ZYTO" range of High-class Machinery includes: Saw Benches and Tables, Spindle Moulders (Pedestal and Bench), Dimension Saw Benches, Combination Saws

S. TYZACK & SON, LTD.
341-343-345 OLD STREET, LONDON, E.C.1

Telephones: CLERKENWELL 8301 (Ten Lines)

LARGE RANGE

"GOLIATH" LEVER SHEARING MACHINES. ALL STEEL.

"LONGLIFE" ALL STEEL M/C VICES.

"ACE" JUNIOR ALL STEEL MULTI ANGLE TABLE VICE.

No. 1 BENDING MACHINE

"GOLIATH" 14 GAUGE ELECTRIC SHEAR.

"ACE" 10" ROTARY MULTI ANGLE TABLE.

"ACE" MINOR 8" MOTORIZED SAW BENCH.

"CRITERION" SURFACE PLATES WITH NEW MIRROR FINISH.

★ **A SELECTION OF OUR PRODUCTS**

BRITISH AND BEST

PRICES DEFY COMPETITION

W.M. URQUHART. 1023 GARRATT LANE, LONDON, S.W.17, ENGLAND
Tel. No. Bal. 3351

WINN

SCREWING MACHINES

The WINN range of Screwing Machines for every duty on Pipe and Bolt Work ; for the Plumber, Pipe Fitter, and Maintenance Engineer. Also High-speed Production Machines with Genuine LANDIS Die Head and Tangential Dies

OVER 70 YEARS' SKILLED EXPERIENCE
BUILT INTO EVERY MODEL

EXPORT INQUIRIES INVITED

CHARLES WINN & CO. LTD

GRANVILLE STREET SOUTH
BIRMINGHAM, 1

No. 3 SIZE, FIG 6197-BE
ELECTRICALLY DRIVEN
LEVER RELEASE SCREWING MACHINE
(Registered Design)

**Manual and Power Driven
Types in Stock**

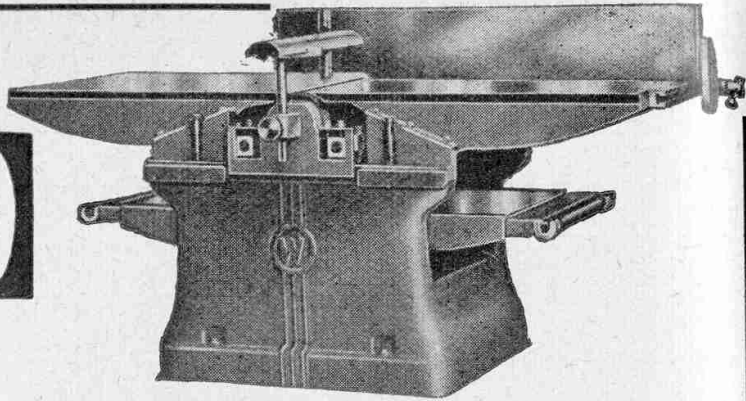

12" x 4" Combined Planing and Thickening machine type PTJ.

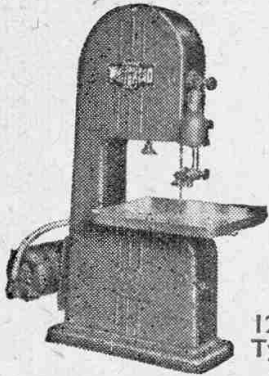

*"Britain's
Finest
Junior Tools"*

12" Bandsawing Machine
Type BJ (Bench Model)



Manufactured at **WELL LANE, HALIFAX, ENGLAND**
Phone : HALIFAX 5271-2-3

**POWELL
"PICK-UP"
DRUM TRUCK**

remarkably effective



immensely strong

Capacity 3 to 8 cwts., also models with 16" dia. wheels.

**"BIN MASTER"
BIN CARRIER**

beautifully balanced



a girl can operate

Type "PC" for heavy duty jobs, also for full size Churns, Carboys, etc.

also 4-wheeled DRUM TRUCKS, BARREL STANDS (for Side or End Pouring), SACK TRUCKS, etc.
POWELL & CO., "DRUM MASTER" PRODUCTS, BURRY PORT, CARMS., S. WALES

THE SWORDFISH

PROFILE SAW MACHINE

Also recently introduced
SPINDLE MOULDER & PLANER

- High Speed Planing, Moulding, Panel Raising, Grooving, etc.
- Table 9" x 18"
- Will plane board 4" wide
- Will groove or mould $\frac{5}{8}$ " deep to centre of 7" board.
- Bench model as shown, or, on pedestal as floor machine

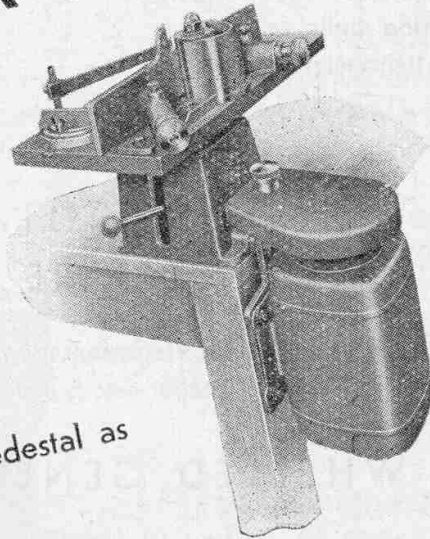

Write for Brochures and Terms

HUGHES

(WOODWORKING) LTD.

Telegrams :
Hughes, Low Moor

Telephone :
Low Moor 668

MOOR ENGINEERING WORKS
LOW MOOR · BRADFORD · YORKS

Precision —
 the reason
 for the
 of the **WILLSON**
Lathe
 Popularity

Brief Specification: Swing 17" diameter over bed. 3' 10" between centres. 8' bed. Maximum length of bed supplied 11'. 9 spindle speeds. 24 changes of screw and feed.

PITEL

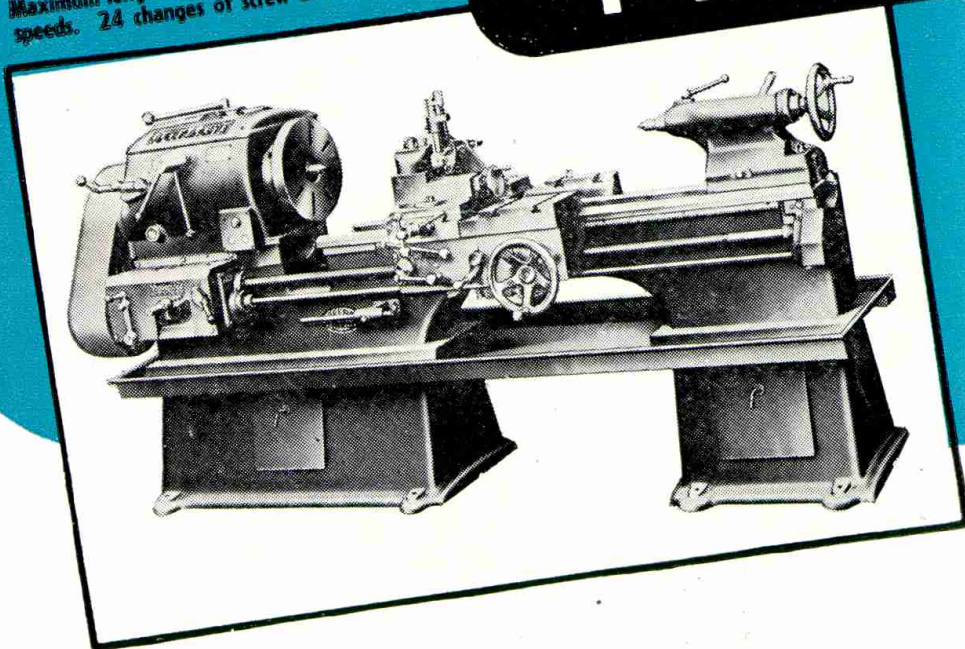

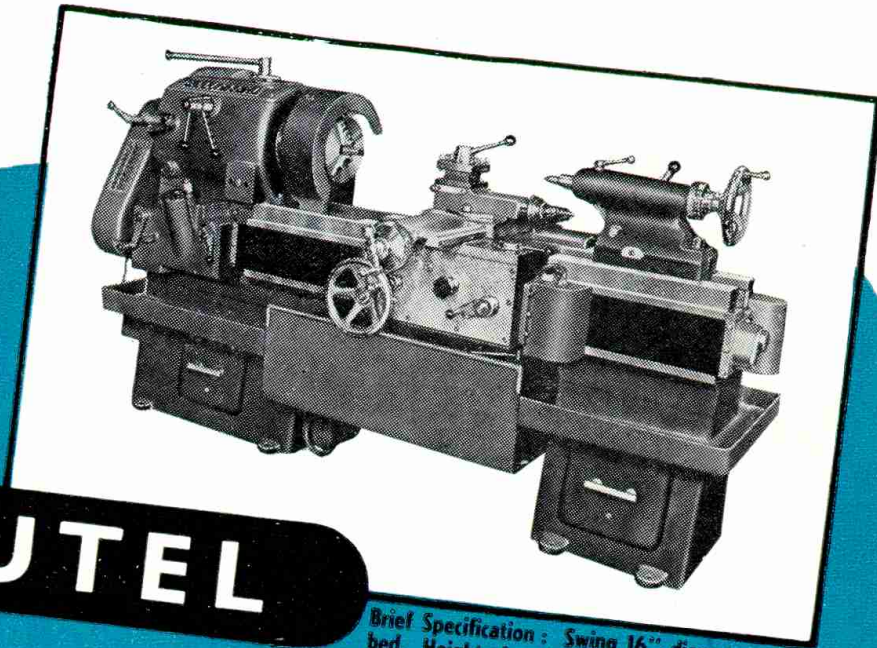

AUTEL

Brief Specification : Swing 16" diameter over bed. Height of centres 7 $\frac{3}{8}$ " ; 7' bed. Swing in gap 18 $\frac{1}{2}$ " x 10" ; 9 spindle speeds (39-716 r.p.m.)

The Willson "Autel" is designed on Safety First principle – **NO MOVING PARTS EXPOSED . . . other than the work.** Illustrated brochure (Spec. 80) free on application.



WILLSON LATHES LTD.
HALIFAX · ENGLAND

TELEPHONES 5844-5

• TELEGRAMS : LATHE, HALIFAX